

Quick Exhaust Valves

- Increases piston speeds, super sensitive diaphragm.
- May be used as differential shuttle valve.

Shuttle Valves

- Allows two separate signals to be applied to the air pilot.
- 0,6 bar differential, Viton seals as standard.

Non Return Valves

- Aluminium or polymer bodies
- Compact



Operating information

Shuttle valve •••005

Working pressure 1,3 - 17 bar
 Working temperature; Standard -10 °C to +180 °C

Quick exhaust valve P4Q

Working pressure: 0,2 - 10 bar
 Working temperature; Standard: -10 °C to +80 °C

VB

Working pressure Max 10 bar
 Working temperature -20 °C to +70 °C

PWA-L

Working pressure 0,2 - 10 bar
 Working temperature; -15 °C to +60 °C

For more information see www.parker.com/euro_pneumatic

Shuttle Valves

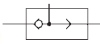
Symbol	Port size	Order code
	M5	M33005
	G1/8	B43005B
	G1/4	B53005A
	G1/4	B53005BS5 (-40°C to +80°C)

Quick Exhaust Valves P4Q Series

Symbol	Port size	Order code
	Standard Version	
	G1/4	P4Q-BA12
	G3/8	P4Q-BA13
	G1/2	P4Q-CA14
	G3/4	P4Q-CA16
	High Temperature Version (Fluorocarbon diaphragm)	
	G3/8	P4Q-BV13
	G1/2	P4Q-CV14
	G3/4	P4Q-CV16

Non Return Valves

Aluminium VB Series

Symbol	Port size	Order code
	G1/8	VB12-Q-NQ-5
	G1/4	VB22-Q-NQ-5
	G1/2	VB42-Q-NQ-5
	G1/2	VB42-S50897 (Viton - dry assembly)

Line mounted non-return valves

Symbol	Push-in connection Ø, mm	Flow rate 6 bar, l/s	Order code
	4	3,33	PWA-L1444
	6	11,00	PWA-L1466
	8	26,67	PWA-L1488

Dimensions (mm)

Quick Exhaust Valves

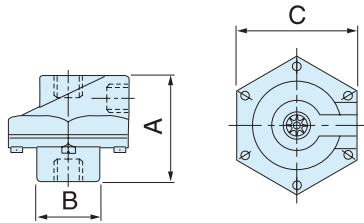

Order code	Port Size	A	B	C
P4Q-B*12	G1/4	52	25	62
P4Q-B*13	G3/8	52	25	62
P4Q-B*14	G1/2	73	38	86
P4Q-B*16	G3/4	73	38	86

Shuttle Valves

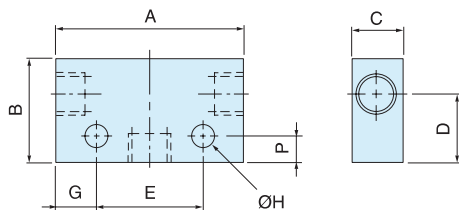

Order code	Port Size	A	B	C	D	E	F	G	H
M33005	M5	27,5	24	15	16,0	15	6	6,3	3,2
B43005B	G1/8	44,0	24	15	16,0	25	6	9,5	4,5
* B53005A	G1/4	52,0	30	22	20,5	35	10	8,5	5,5

* Dimensions as B53005BS5

Non Return Valves - VB - Female

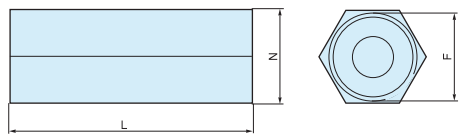

Order code	F	L	N
VB12-Q-NQ-5	G1/8	31	14
VQB22-Q-NQ-5	G1/4	40	17
* VB42-Q-NQ-5	G1/2	59	27

* Dimensions as VB42 / S50897

Non Return Valves - Push-in

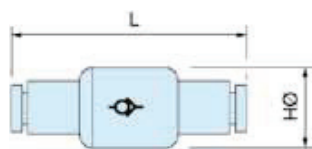

Order code	ØH	L
PWA-L1444	11,0	43,0
PWA-L1466	13,0	49,5
PWA-L1488	13,5	55,0